

NGL[®]

Nasser Global Links
ناصر جلوبل لينكس

NASSER'S
125 YEARS
OF INTERNATIONAL TRADE
1888-2013

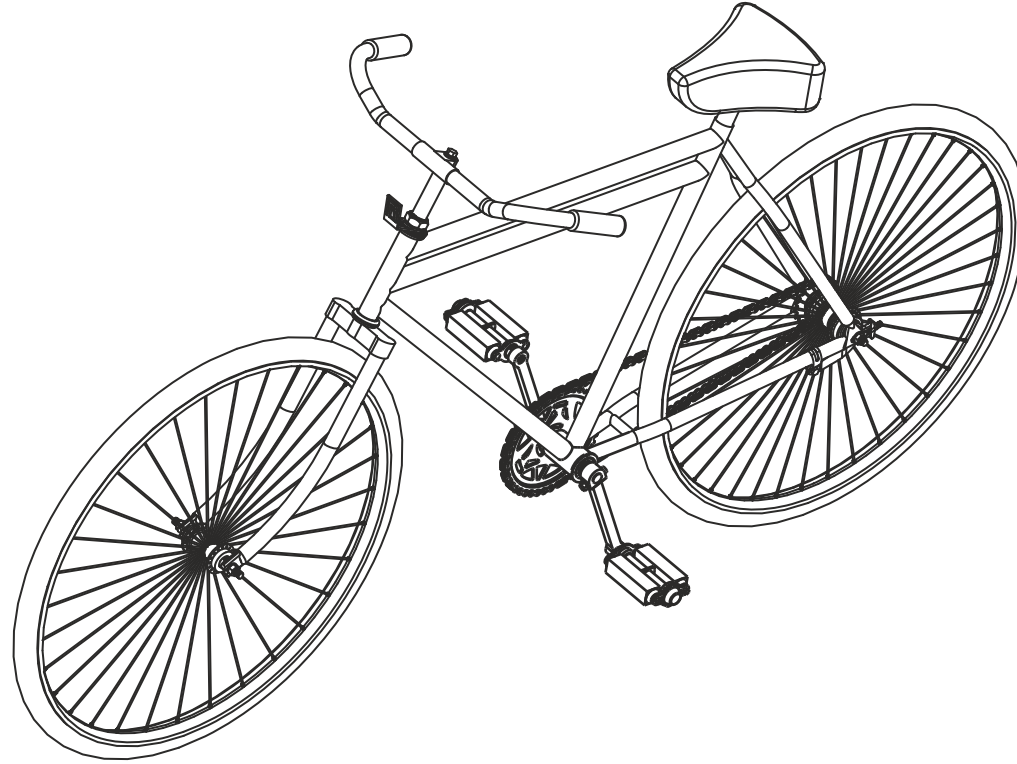

Bicycle Maintenance Manual

SINCERE SERVICE | SECURED SOURCE | SPIRITED SUPPLIER

Frame

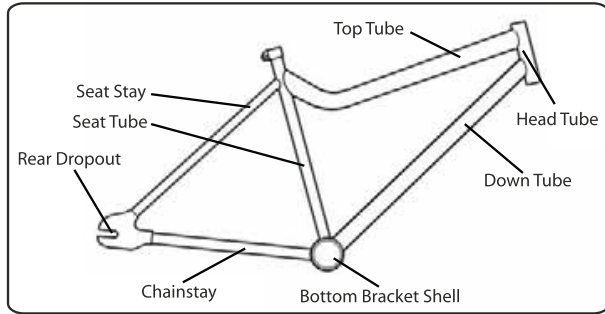

Fork

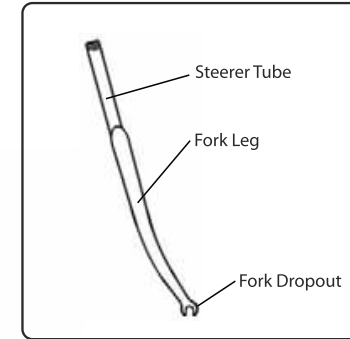

Tire

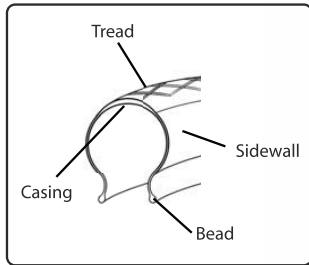

Spoke

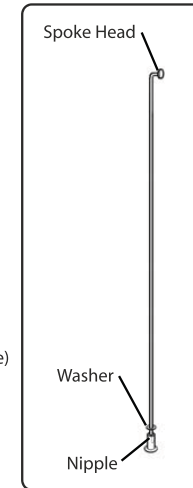



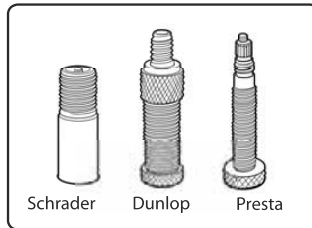

Valve Types

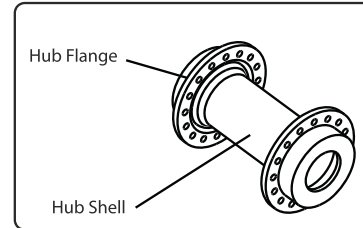

Hub

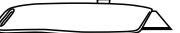

Components

	Tire Lever
	Hacksaw Blade
	Cutting Tool
	Patching Glue

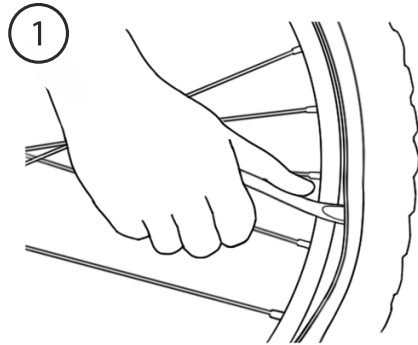

Remove tube

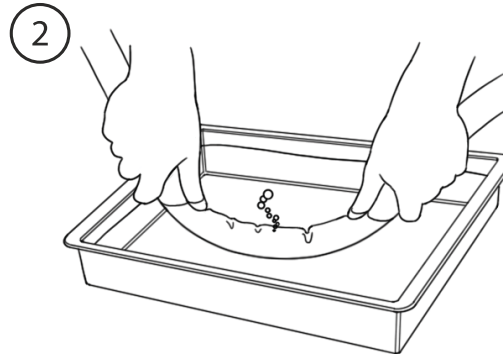

Hold underwater to locate hole

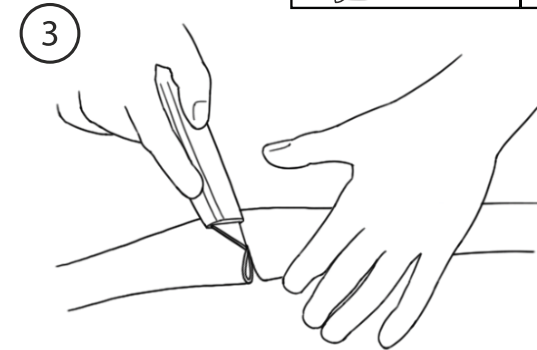

Cut patch from old tube

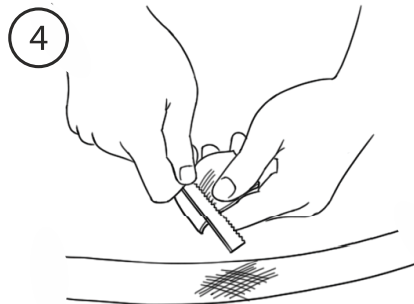

Scratch patch area with hacksaw blade or sandpaper

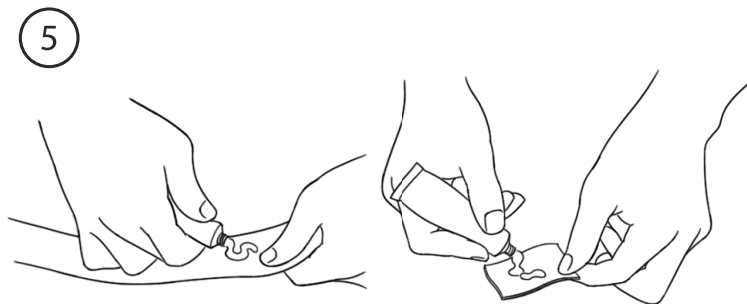

Add patching glue to tube and patch

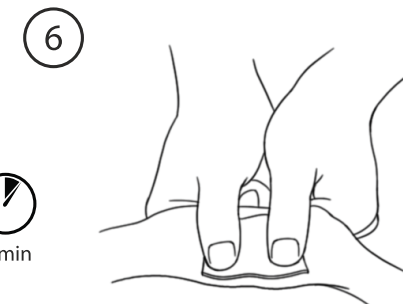

Press patch down hard on tube



Tube Repair

www.nasserglobal.com

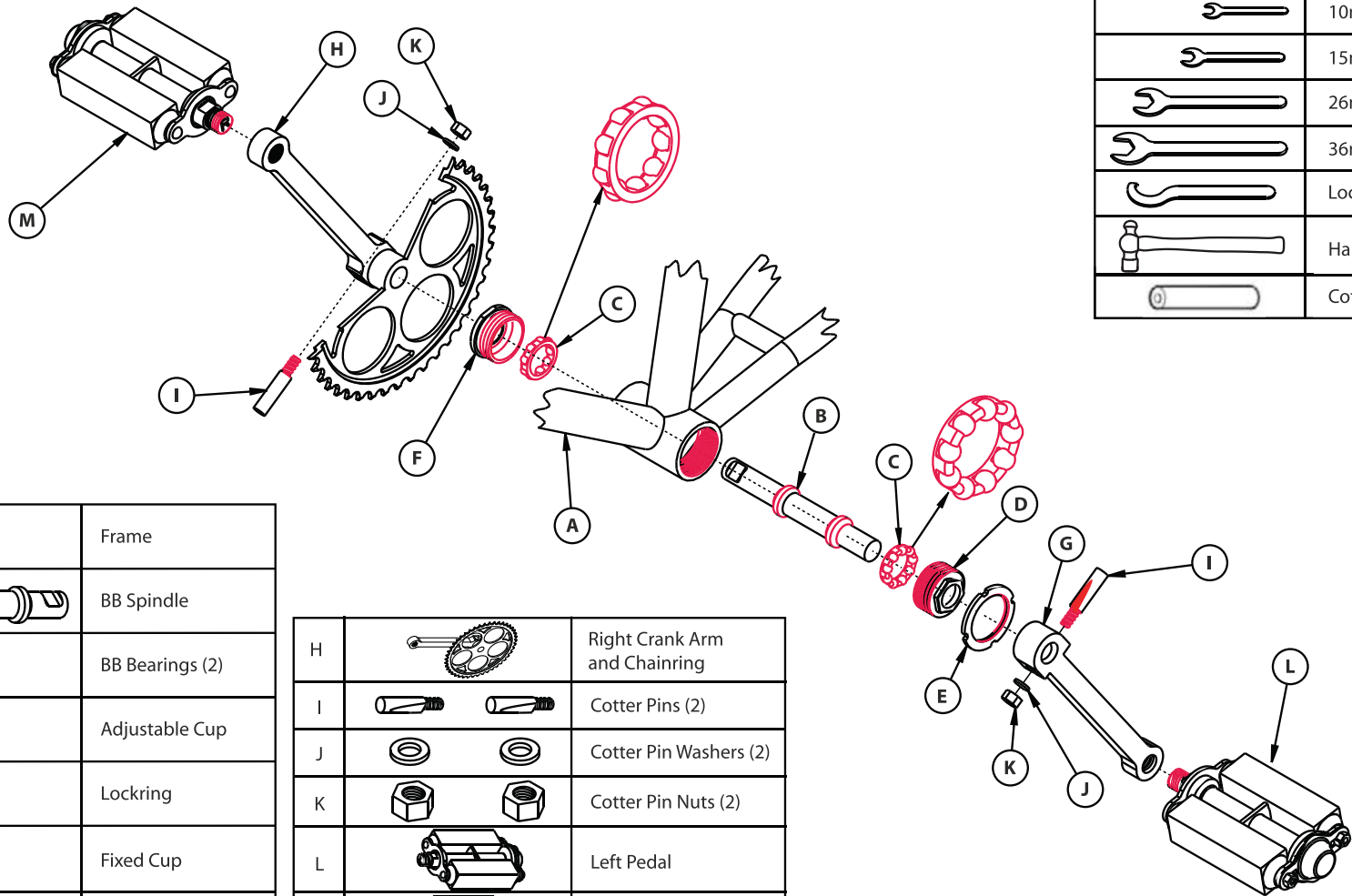











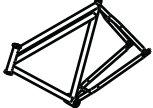
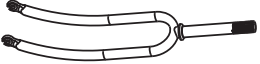

	10mm spanner
	15mm spanner
	26mm spanner
	36mm spanner
	Lockring spanner
	Hammer
	Cotter Anvil

A		Frame
B		BB Spindle
C		BB Bearings (2)
D		Adjustable Cup
E		Lockring
F		Fixed Cup
G		Left Crank Arm



H		Right Crank Arm and Chainring
I		Cotter Pins (2)
J		Cotter Pin Washers (2)
K		Cotter Pin Nuts (2)
L		Left Pedal
M		Right Pedal

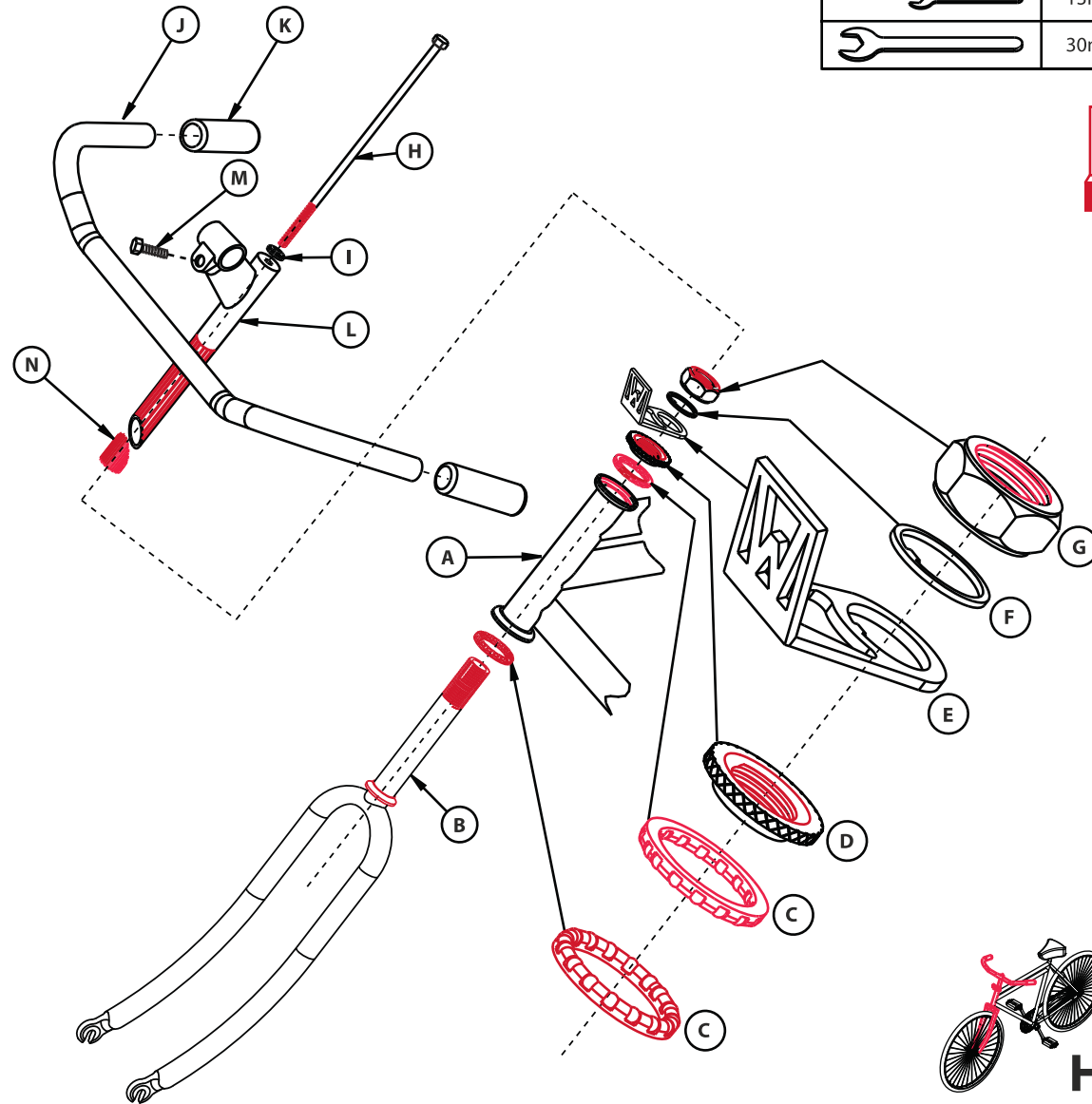

Bottom Bracket

A		Frame
B		Fork
C		Headset Bearing (2)
D		Upper Headset Race
E		Lamp Bracket
F		Headset Spacer
G		Lock Nut
H		Expander Bolt
I		Washer
J		Handlebars
K		Handlebar Grips (2)
L		Stem
M		Stem Bolt
N		Expander Wedge



	13mm spanner
	30mm spanner







NGL[®]

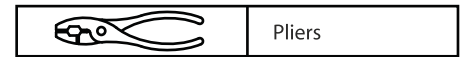
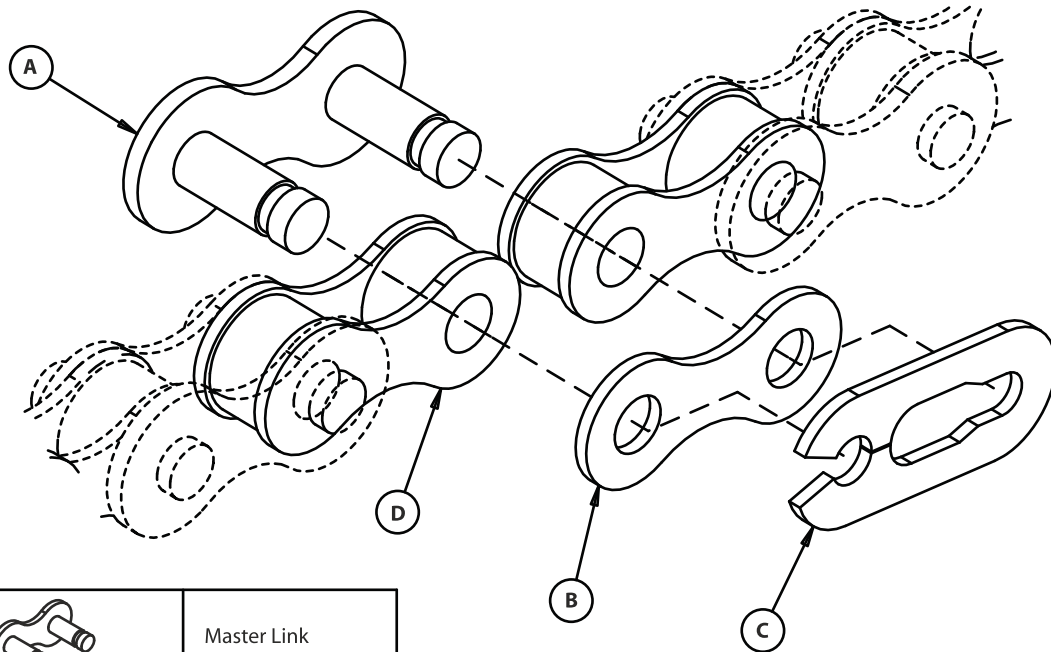

Headset

www.nasserglobal.com



A		Master Link
B		Master Link Side Plate
C		Retaining Clip
D		Chain

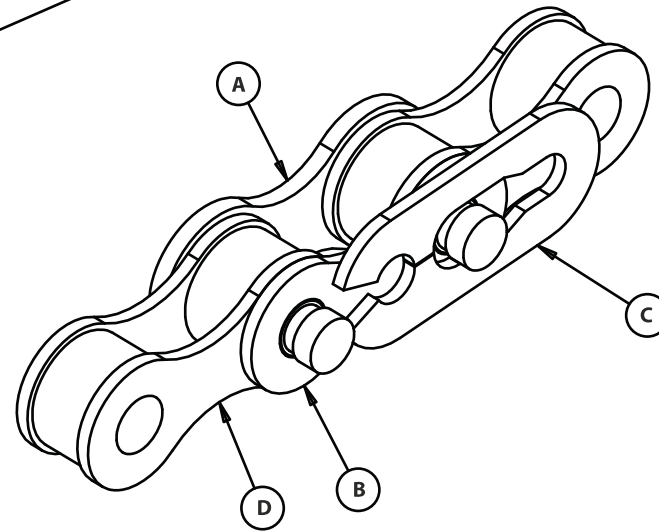





NGL[®]



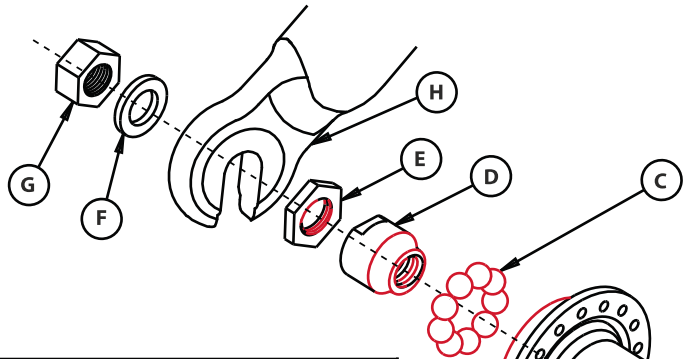





Chain

www.nasserglobal.com

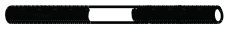
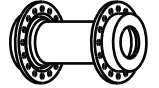

	15mm spanner
	17mm spanner
	15mm cone spanner



A		Axle
B		Hub Shell
C		Bearing (2)
D		Cone
E		Locknut
F		Axle Washers (2)
G		Axle Nuts (2)

H		Fork
---	--	------

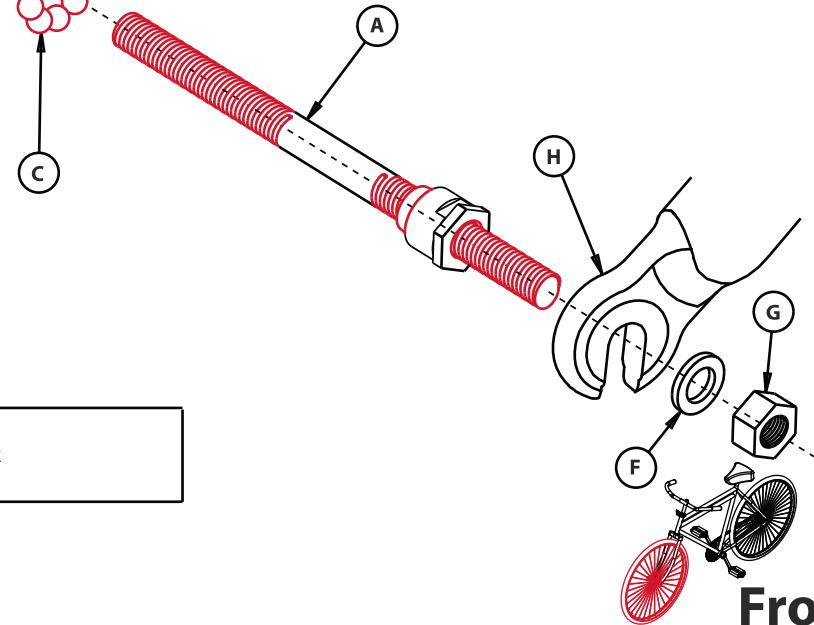

Front Hub

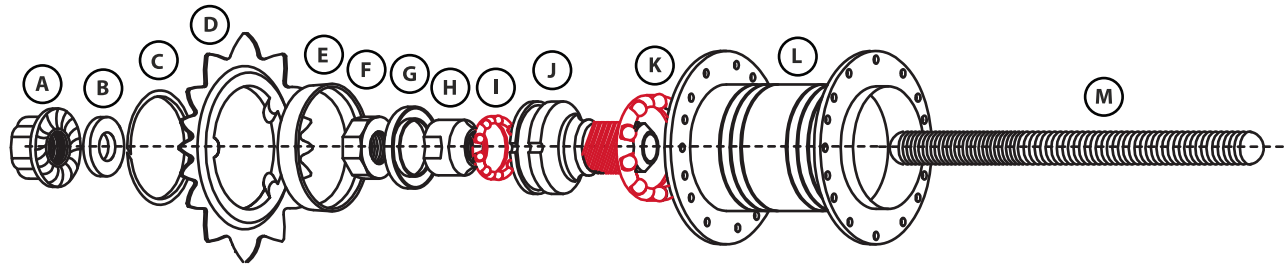

	10mm Spanner
	15mm Spanner
	17mm Spanner
	Screwdriver
	15mm cone spanner

A		Axle Nut (2)
B		Axle Washers (2)
C		Snap Ring
D		Cog
E		Right Dust Cover
F		Lock Nuts (2)
G		Bearing Shield
H		Cone
I		Small Bearing

J		Hub Driver
K		Large Bearings (2)
L		Hub Shell
M		Axle
N		Clutch Cone
O		Clutch Washer
P		Clutch Spring
Q		Spring Holder
R		Brake Shoes

S		Brake Cone
T		Left Dust Cover
U		Brake Arm
V		Washer
W		Bolt
X		Brake Arm Clip
Y		Nut

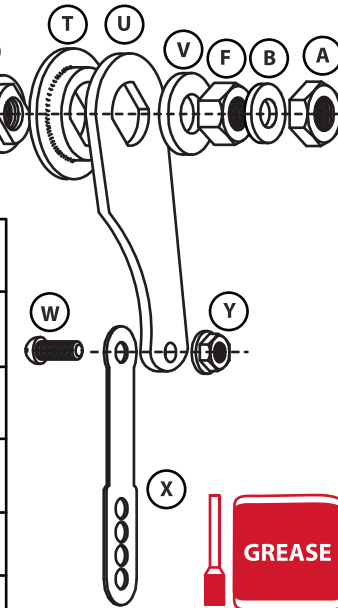

KT Rear Hub

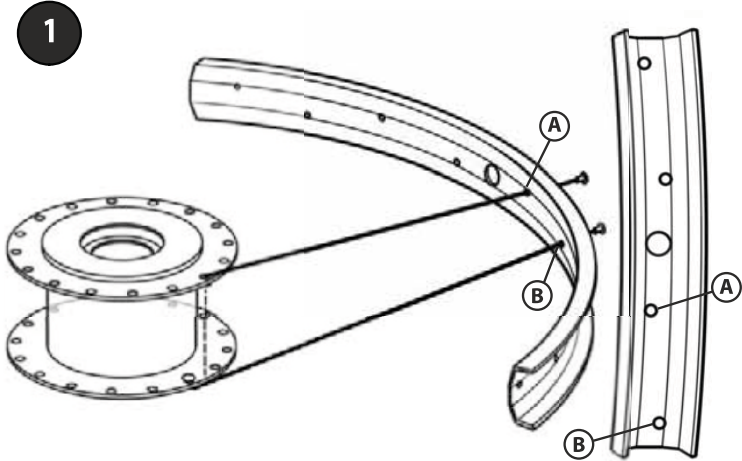

-or-

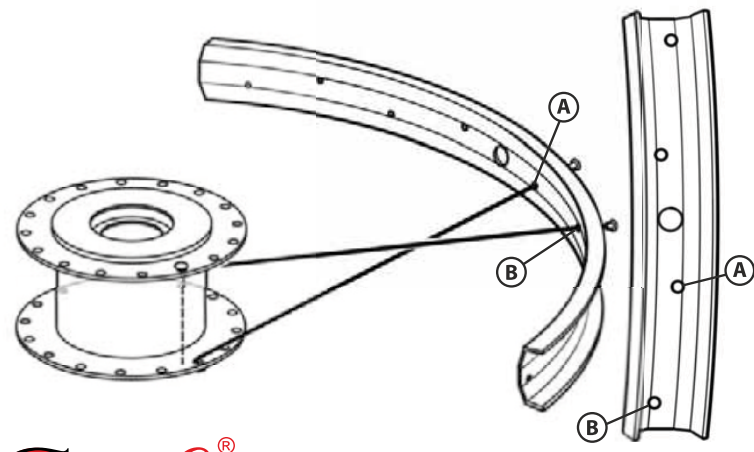

2

# of crossings	Hub holes
4x	10
3x	8
2x	6
1x	4

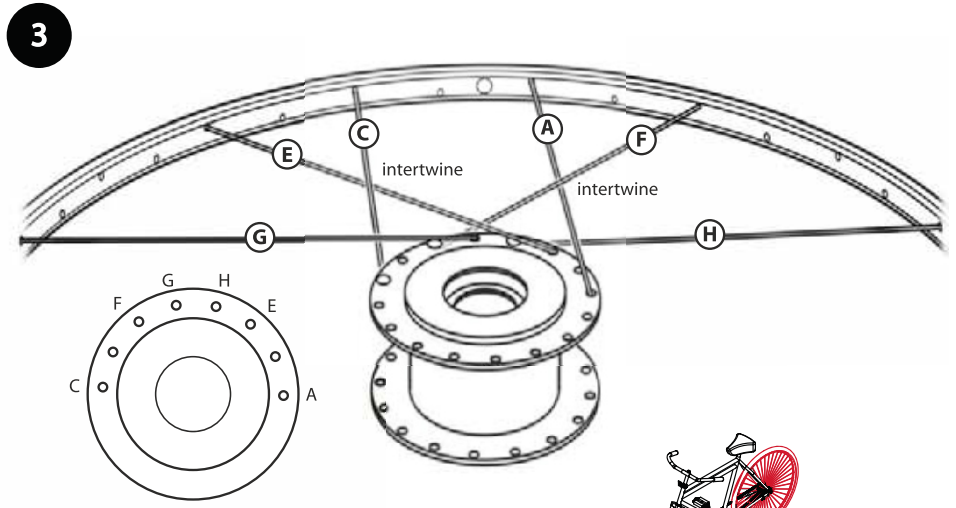
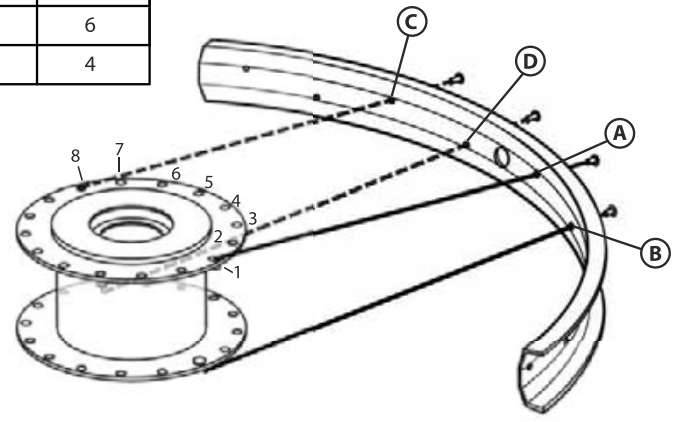

Wheel Lacing



Truing

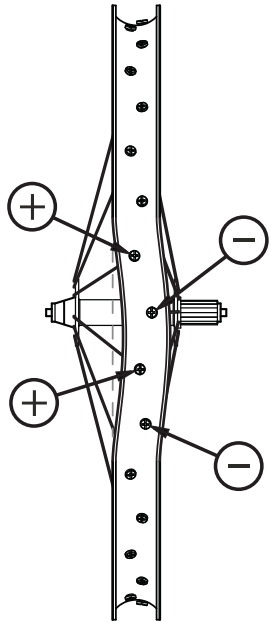

Rounding

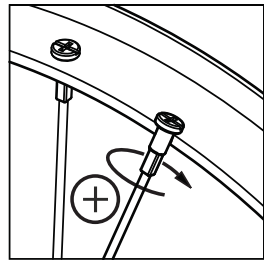
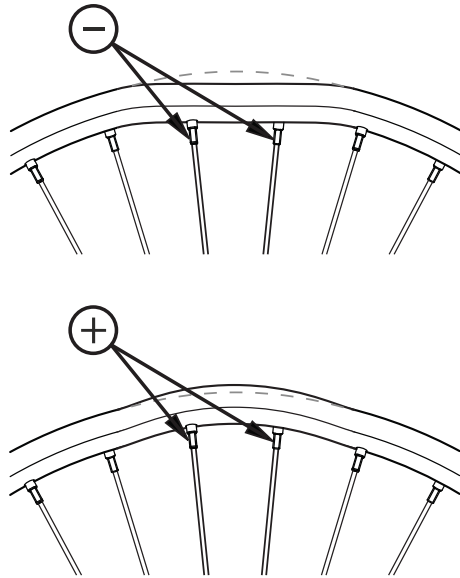

Tighten

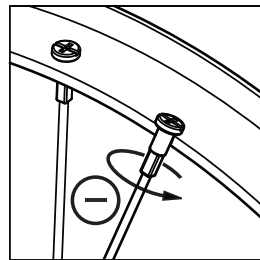

Loosen

Dishing

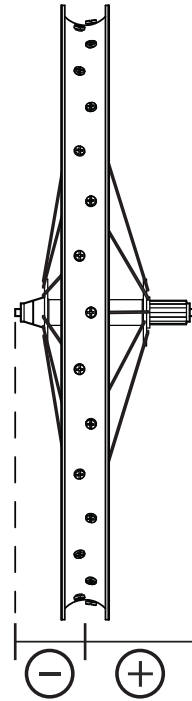

Rim Off Center

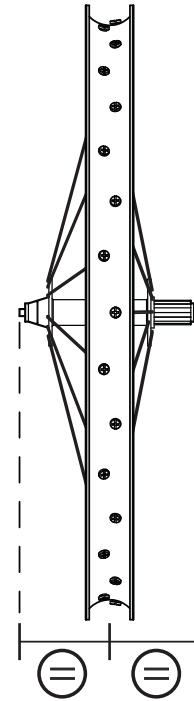

Correctly Dished

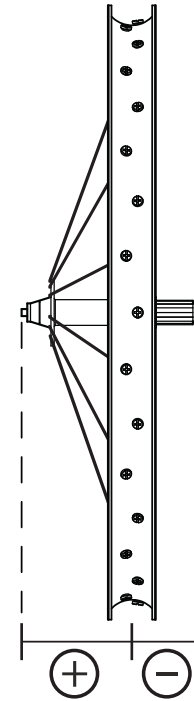

Rim Off Center



Wheel Alignment



Nasser Global Links

Bringing you the Globe...



1 Palekar Chambers, 12, First Marine Street, Mumbai 400 002. INDIA.
M: +91 9820068323 T: +91 22 22015044 E: info@nasserglobal.com W: www.nasserglobal.com

SINCERE SERVICE | SECURED SOURCE | SPIRITED SUPPLIER